

FACE PLATE FOR GLASS DOOR

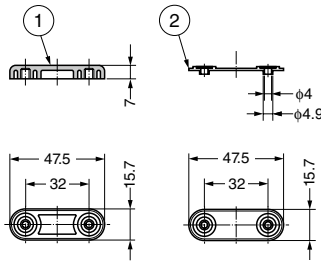

SDS-50G

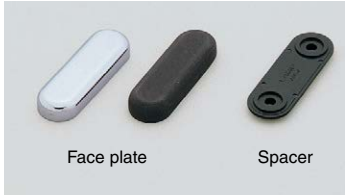

Features

Can be used with SDS or NSDX-GZ.

Parts Included

Countersunk head screw M4x14

Cut Out Dimensions

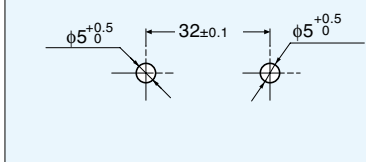

No.	Part Name	Material	Finish/Colour	Carton
①	Face Plate	Zinc Alloy (ZDC)	Chrome (CR), Black (BL)	1 pc
②	Spacer	ABS	Black	2 pcs

Item Code	Item Name	Weight	Box	Carton
180-100-260	SDS-50G-CR	25 g	50 pcs	200 pcs
180-928-046	SDS-50G-BL	25 g	50 pcs	200 pcs

MOUNTING PLATE FOR NSDX

NSDX-CZ, NSDX-AZ, NSDX-GZ

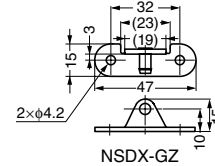
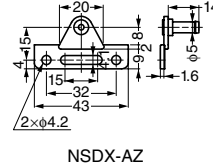
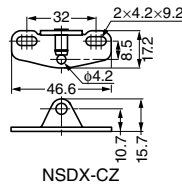

Item Code	Item Name	Type	Weight	Box	Carton
180-109-460	NSDX-CZ	Clip on	13 g	160 pcs	640 pcs
180-109-019	NSDX-AZ	Clip on for 20 mm width Aluminium Frame	11 g	320 pcs	1280 pcs
180-109-459	NSDX-GZ	Clip on Mounting Plate for Glass Door	14 g	8 pcs	640 pcs

BRACKET FOR DISK DAMPER UDD



UDD-BKT



Application Example

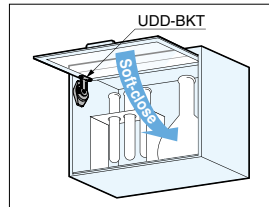

Features

Bracket of disk damper UDD (P.523) for upward-opening doors.

Remarks

- Catch is needed for holding door in opened position.
- SDS-50G (above) face plate available for glass/acrylic doors.

Cut Out Dimensions

No.	Door Thickness T	A	B	C	D	E
①	5	46	70	49	(95)	(26)
②	15	54	82	57	(111)	(40)
③	18	57	86	60	(117)	(44)

*① is for glass/acrylic door with SDS-50G.
②, ③ is for wooden door.

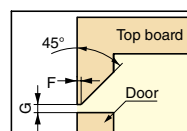
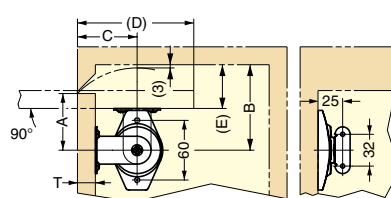

F	G
1	3
2	4
3	5

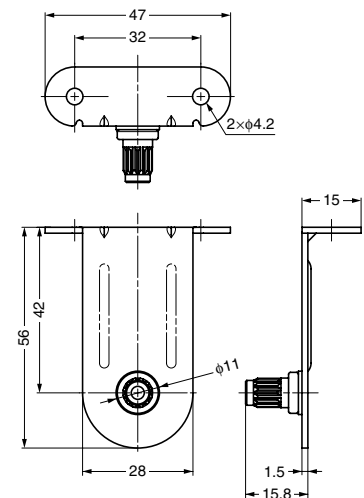
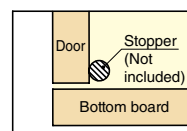

Item Code	Item Name	Material	Finish	Weight	Carton
180-026-764	UDD-BKT	Stainless Steel (SUS304)	Plain	33 g	60 pcs