

HÄFELE 165° STANDARD HINGES



- > Opening angle 165°, Ø 35 mm cup
- > Screw fixing cup
- > Click on arm
- > For door thickness up to 24 mm see table below
- > Full overlay mounting steel cup and hinge arm, half overlay mounting steel cup and zinc alloy arm
- > Order fixing screws separately
- > Order qty: 1 pc



Soft close clip on fitting for sprung hinges shown opposite

Häfele 165° hinge

Minimum gap for doors with chamfered edges (r = 1 mm) with factory setting

Door thickness mm	Distance to cup E mm				
	3.0	4.0	5.0	6.0	7.0
16-23	0.0	0.0	0.0	0.0	0.0
24	0.0	0.0	0.0	2.6	5.1
Minimum gap F					

Drilling pattern for cup fixing

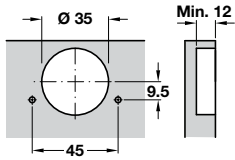

Full overlay mounting

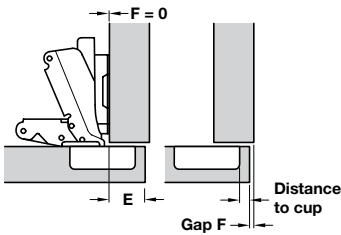

Door overlay mm								
13	14	15	16	17	18	19	20	
			3	4	5	6	7	0
3	4	5	6	7				3
Distance to cup E mm						Mounting plate height mm		



Fixing	Click on
Screw fixing	312.23.550

Half overlay mounting

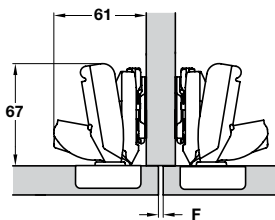

Drawing show application on 0 mm thick mounting plate

Door overlay mm								
4	5	6	7	8	9	10	11	
			3	4	5	6	7	0
3	3	3	3	3				3
Distance to cup E mm						Mounting plate height mm		



Fixing	Click on
Screw fixing	312.23.755

Inset mounting

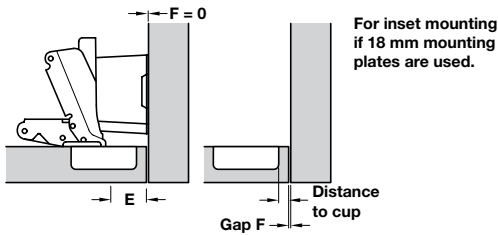

Door thickness mm							
16	17	18	19	20	21	22	
3	3	3	3	3	3	3	2
4	4	4	4	4	4	4	1
5	5	5	5	5	5	5	0
Distance to cup E mm							Gap F mm



18 mm mounting plate for inset mounting shown on page 28

Fixing	Click on
Screw fixing	312.23.550

Add on soft close 165°

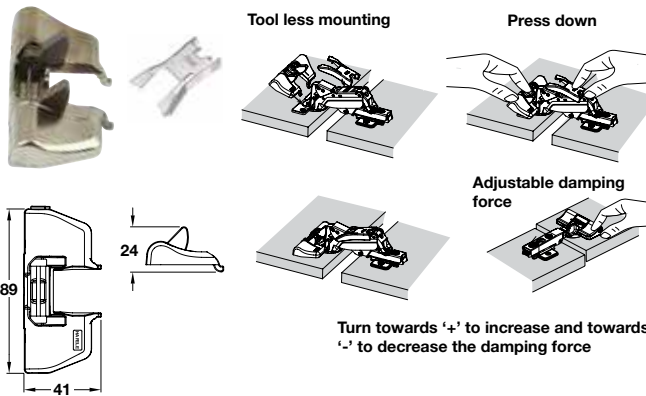

- > For use with 165° hinge only
- > Order qty: 1 pc



Recommended position of soft close is shown on page 15

Opening angle	Cat. No.
165°	312.07.712

YOU ALSO NEED:

MOUNTING PLATES
Pages 28-29

FIXING SCREWS
Section 13 page 88

OPTIONAL ACCESSORIES
Pages 109-121

Mounting plate for Häfele concealed hinges

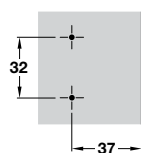

- > Hospa screw fixing
- > One part plate with ± 2 mm height adjustment via slots
- > Nickel-plated steel
- > Order fixing screws separately
- > Order qty: 1 pc



A wider range of mounting plates are shown on pages 28-29

Height	Click on
0 mm	312.30.540



TCH TECHNOLOGY 2018, © Häfele U.K. Ltd 2018. Dimensional data not binding. We reserve the right to alter specifications without notice.

MOUNTING PLATES FOR HÄFELE CLICK ON HINGES



Häfele click on hinges are shown on pages **16-25**

9

Furniture Hinges and Flap Fittings: Hinges

Click on mounting plate for Häfele concealed hinges

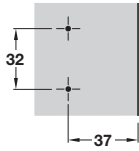

For Hospa screws

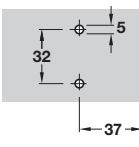
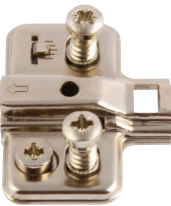

With pre-mounted Euro screws

- > Hospa screw fixing or pre-mounted with euro screw
- > Two part plate with ± 2 mm height adjustment via cam screw
- > Height adjustment indicator
- > Nickel-plated steel
- > Order fixing screws separately for Hospa screw fixing versions
- > Order qty: 1 pc



Height	Hospa screws	Euro screws
0 mm	312.33.500	312.33.510
3 mm	312.33.503	312.33.513



Information on mounting plate adjustment is shown on page **14-15**

Click on mounting plate for Häfele concealed hinges

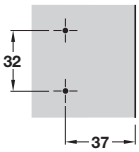

For Hospa screws

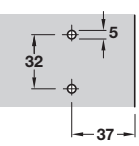

With pre-mounted Euro screws

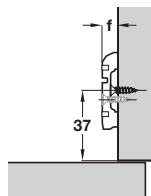

Height F = mounting plate height shown in tables

- > Hospa screw fixing or pre-mounted with euro screw
- > One part plate with ± 2 mm height adjustment via slots
- > Nickel-plated steel
- > Order fixing screws separately for Hospa screw fixing versions
- > Order qty: 1 pc



Height	Hospa screws	Euro screws
0 mm	312.30.540	312.30.550
3 mm	312.30.543	312.30.553

Click on mounting plate for Häfele concealed hinges

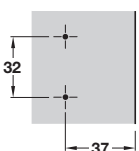

For Hospa screws

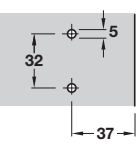

With pre-mounted Euro screws

- > Hospa screw fixing or pre-mounted with euro screw
- > Height adjustment ± 2 mm
- > Zinc
- > Order fixing screws separately for Hospa screw fixing versions
- > Order qty: 1 pc



Height	Hospa screws	Euro screws
18 mm	312.33.520	312.33.530

Add on soft close

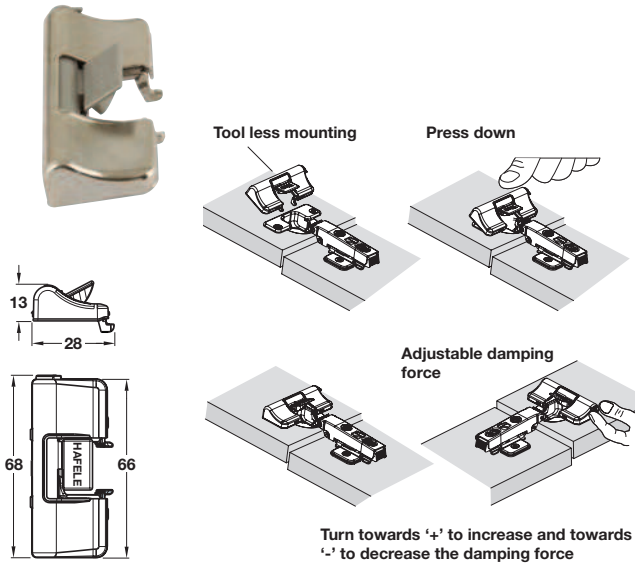

- > For use with 110° click on hinges shown on pages **18-19**, and post hinges shown on page **25**
- > Order qty: 1 pc



Recommended position of soft close is shown on page **15**

	Cat. No.
Add on soft close	312.07.711



Cover caps for Häfele concealed hinges



- > Only for use with 110°, pie-cut and post hinges, shown on pages **22-25**
- > Nickel-plated steel
- > Order qty: 1 pc

	Cat. No.
Cover cap	312.03.660



MOUNTING PLATES FOR HÄFELE REFRIGERATOR HINGES

Keyhole mounting plate for Häfele concealed refrigerator hinge

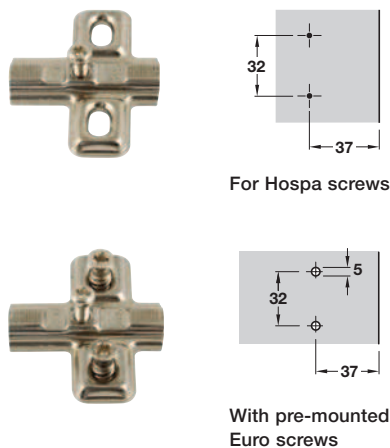

- > Hospa screw fixing or with pre-mounted Euro screws
- > For use with refrigerator hinge
- > One part plate with ± 2 mm height adjustment via slots
- > Nickel-plated steel
- > Order fixing screws separately for Hospa screw fixing versions
- > Order qty: 1 pc



For use with Häfele refrigerator hinge shown on page **26**

	FIXINGS REQUIRED HOSPA Ø 3,5	Fixings included	25 YEARS
Height	Hospa screws	Pre-mounted	
0 mm	312.46.510	312.46.520	
3 mm	312.46.513	312.46.523	